

Please note that the data given here has been taken from the online catalog. For comprehensive information and data, please refer to the user documentation at <http://www.download.phoenixcontact.com>. The General Terms and Conditions of Use apply to Internet downloads.

► Extract from the online catalog



PCB terminal block, nominal current: 16 A, rated voltage: 250 V, pitch: 5.0 mm, no. of positions: 5, mounting: Soldering, type of connection: Screw connection, connection direction from the conductor to the PCB: 45°

The illustration shows the 15-position version.

Order No.	1988833
Ord designation	PTA 1,5/ 5-5,0
EAN	4046356036825
Pack	100 Pcs.
Customs tariff	85369010
Catalog page information	Page 131 (NTK-2005)

► Product notes

WEEE/RoHS-compliant since: 08/26/2003



► Technical data

Dimensions / positions

Pitch	5 mm
Dimension a	20 mm
Number of positions	5
Pin dimensions	1,0 mm
Pin spacing	5 mm
Hole diameter	1.3 mm
Screw thread	M 2,6
Tightening torque, min	0.4 Nm

Technical data

Insulating material group	I
Rated surge voltage (III/3)	4 kV
Rated surge voltage (III/2)	4 kV
Rated surge voltage (II/2)	4 kV
Rated voltage (III/2)	320 V
Rated voltage (II/2)	630 V
Connection in acc. with standard	EN-VDE
Nominal current I_N	16 A
Nominal voltage U_N	250 V
Nominal cross section	2.5 mm ²
Maximum load current	16 A
Insulating material	PA
Inflammability class acc. to UL 94	V0
Internal cylindrical gage	A1 / B1
Stripping length	5 mm

Connection data

Conductor cross section, rigid min.	0.14 mm ²
Conductor cross section, rigid max.	2.5 mm ²
Conductor cross section flexible min.	0.14 mm ²
Conductor cross section, flexible max.	2.5 mm ²
Conductor cross section flexible, with ferrule without plastic sleeve min.	0.25 mm ²
Conductor cross section flexible, with ferrule without plastic sleeve max.	1.5 mm ²
Conductor cross section flexible, with ferrule with plastic sleeve min.	0.25 mm ²
Conductor cross section flexible, with ferrule with plastic sleeve max.	1.5 mm ²
Conductor cross section AWG/kcmil min.	26
Conductor cross section AWG/kcmil max	14
2 conductors with same cross section, solid min.	0.14 mm ²
2 conductors with same cross section, solid max.	1 mm ²
2 conductors with same cross section, flexible, min.	0.14 mm ²
2 conductors with same cross section, flexible max.	0.75 mm ²
2 conductors with same cross section, flexible, ferrules without plastic sleeve min.	0.25 mm ²
2 conductors with same cross section, flexible, ferrules without plastic sleeve, max.	0.34 mm ²
2 conductors with same cross section, flexible, TWIN ferrules with plastic sleeve, min.	0.25 mm ²
2 conductors with identical cross section, flexible TWIN ferrules with plastic sleeve, max.	0.75 mm ²

► Drawings

Drilling diagram

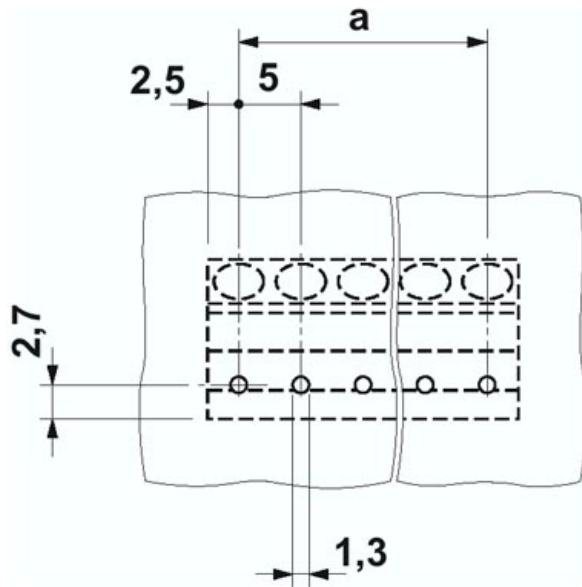

Dimensioned drawing

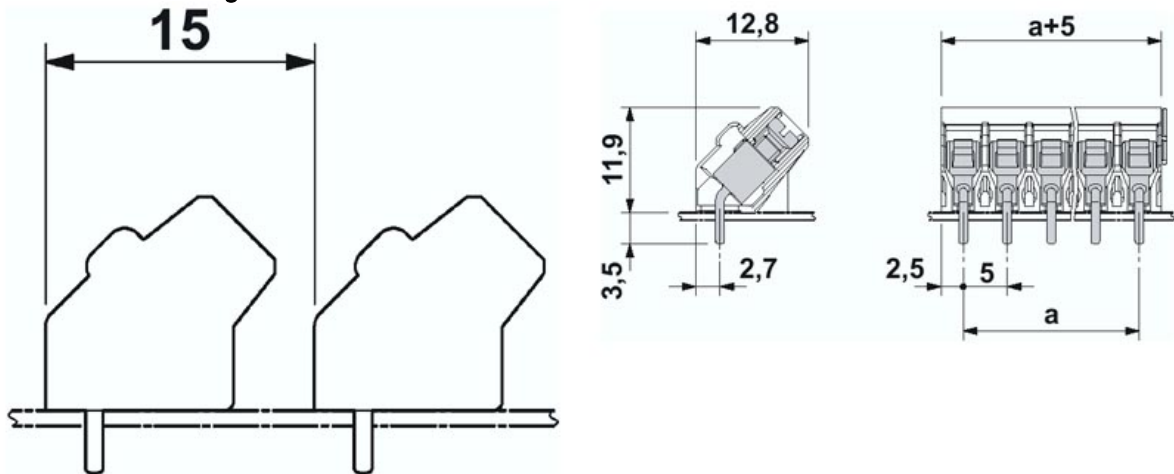

► Accessories

Item	Designation	Description
Marking		
0804183	SK 5/3,8:FORTL.ZAHLEN	Marker card, printed horizontally, self-adhesive, 12 identical decades marked 1-10, 11-20 etc. up to 91-(99)100, sufficient for 120 terminal blocks
Tools		
1205053	SZS 0,6X3,5	Screwdriver, bladed, matches all screw terminal blocks up to 4.0 mm ² connection cross section, blade: 0.6 x 3.5 mm, without VDE approval



► Address

PHOENIX CONTACT Inc., USA
586 Fulling Mill Road
Middletown, PA 17057
USA
Phone (800) 888-7388
Fax (717) 944-1625
<http://www.phoenixcon.com>
Phoenix Contact
Technical modifications reserved;